

TTP-244 / TTP-244 Plus

**THERMAL TRANSFER / DIRECT THERMAL BAR
CODE PRINTER**

**USER'S
MANUAL**

CONTENTS

1. PRODUCT INTRODUCTION	2
1.1 Compliances	2
1.2 Effective Print Area	3
1.3 Available Bar Codes	3
1.4 Various Sensors	4
1.5 Supply Specifications	6
1.5.1 Types of Paper.....	6
1.5.2 Specifications.....	6
1.5.3 Ribbon Sizes and Shapes.....	8
2. GETTING STARTED	9
2.1 Unpacking and Inspection	9
2.2 Equipment Checklist	9
2.3 Printer Parts	10
2.4 External Label Roll Mount (Option)	13
2.5 Buttons and Indicators	14
3. SET UP.....	15
3.1 Setting Up the Printer	15
3.2 Loading Label and Tag Stock	15
3.3 Ribbon Loading Instructions.....	19
3.4 Install External Label Roll Mount (Option).....	23
3.5 Self Test.....	24
3.6 Dump Mode.....	26
3.7 Install SD Memory Card (TTP-244 Plus Model only / Option).....	27
4. USING PRINTER.....	29
4.1 Power-on Utilities	29
4.1.1 Self Test Utility	29
4.1.2 Gap Sensor Calibration Utility	29
4.1.3 Printer Initialization	30
4.2 Troubleshooting Guide.....	31

1. PRODUCT INTRODUCTION

Thank you very much for purchasing TSC bar code printer. The attractive desktop printer delivers superior performance at an economical price. Both powerful and easy-to-use, this printer is your best choice among desktop direct thermal and thermal transfer label printers.

This printer offers both thermal transfer and direct thermal printing, 32-bit RISC multi-tasking processor, print speed up to 4.0 inches per second features. It can accept a wide range of media, including continuous, die-cut, and fan-fold labels or tags for both thermal transfer and direct thermal printing. All of the most frequently used bar code formats are available. Fonts and bar codes can be printed in any one of four directions. And it provides a choice of eight different sizes of alphanumeric fonts. By using font multiplication, an even greater range of sizes is possible. Smooth fonts can be downloaded from the software. In addition, It is capable of independently executing BASIC programming functions, including arithmetic, logical operation, loop, flow-control and file management, among others. This programming capability provides the greatest efficiency in label printing. The status of printer and error messages may either be printed out or viewed on a monitor by means of the connection.

Specifications, accessories, parts and programs are subject to change without notice.

1.1 Compliances

FCC Class A, CE Class A, C-Tick Class A, TÜV/Safety, CCC

CAUTION
1. HAZARDOUS MOVING PARTS IN CUTTER MODULE. KEEP FINGER AND OTHER BODY PARTS AWAY.
2. THE MAIN BOARD INCLUDES REAL TIME CLOCK FEATURE HAS LITHIUM BATTERY CR2032 INSTALLED. RISK OF EXPLOSION IF BATTERY IS REPLACED BY AN INCORRECT TYPE.
3. DISPOSE OF USED BATTERIES ACCORDING TO THE MANUFACTURER INSTRUCTIONS.

此为A级产品，在生活环境中，该产品可能会造成无线电干扰。在这种情况下，可能需要用户对干扰采取切实可行的措施。

A급기기

(업무용 정보통신기기)

이 기기는 업무용으로 전자파 적합등록을 한 기기이오니, 판매자 또는 사용자는 이 점을 주위하시기 바라며, 만약 잘못 판매 또는 구입하였을 때에는 가정용으로 교환하시기 바랍니다.

1.2 Effective Print Area

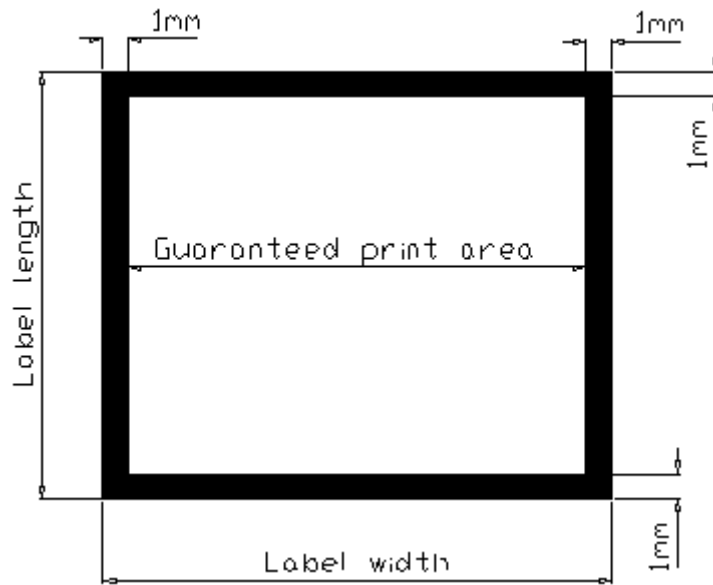

Label/Ticket Print Length	12 mm~2286 mm
Effective Print Length	10 mm~2284 mm
Label/Ticket Print Width	25 mm~104 mm
Effective Print Width	23 mm~102 mm
No Print Area	1 mm

1.3 Available Bar Codes

1D bar code

- Code 39
- Code 93
- Code 128 UCC
- Code 128, Subsets A, B, and C
- Codabar
- Interleaved 2 of 5
- EAN-8, EAN-13, EAN-128
- UPC-A, UPC-E
- EAN and UPC with 2 or 5 digits add-on

- MSI
- PLESSEY

- Postnet
- China post

2D bar code

- Maxicode
- PDF-417
- DataMatrix
- QR code
- GS1 DataBar family (RSS)

1.4 Various Sensors

Feed Gap Sensor

The feed gap sensor detects a label gap to locate the starting print position of the next label. The sensor is mounted 4 mm off the center line of the main mechanism.

In case of Label

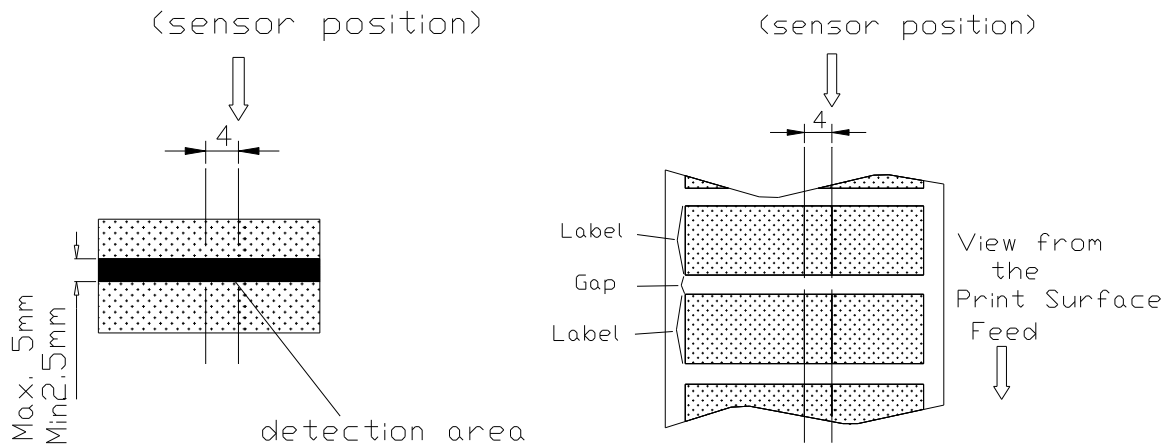

Black Mark Sensor

The black mark sensor locates the position of label by emitting infrared rays onto the black mark at the back of the ticket. The sensor is mounted 5.75 mm off the center line of the ticket roll width on the mechanism.

In case of Ticket

The default sensor position is (1) as shown on the figure below. To change to the (2) position, the customer should notify the manufacturer in advance. There can be only one position for the sensor. Once the sensor position is agreed upon, it can not be changed afterwards.

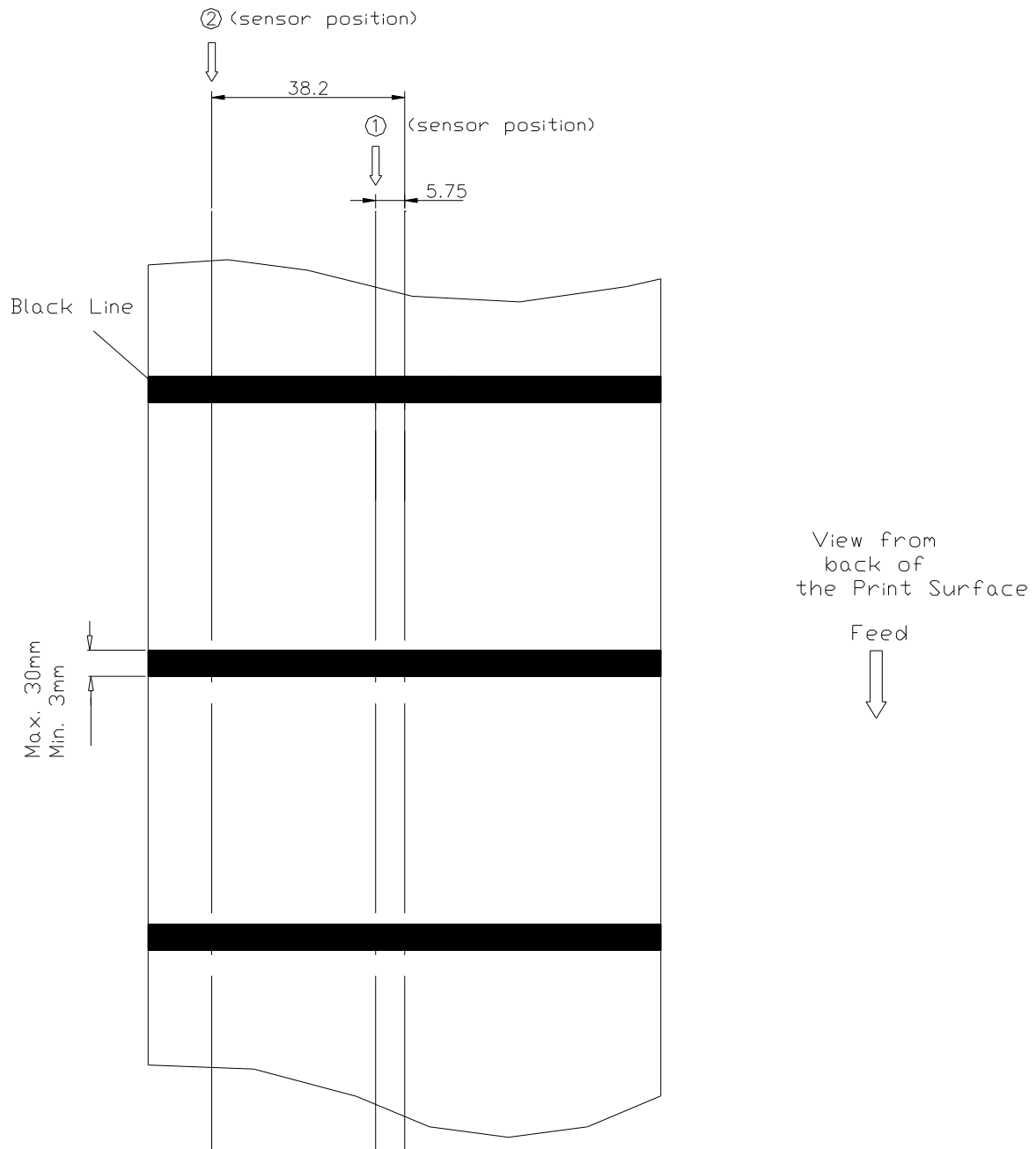

Ribbon End Sensor

The sensor detects the end portion of the ribbon. The ribbon end must be transparent.

Label End Sensor

The sensor detects the end portion of the label.

Peel off Sensor

The sensor detects the backing paper of a label.

Ribbon encoder

The encoder is used to detect if the ribbon is broken.

1.5 Supply Specifications

1.5.1 Types of Paper

Two types of media are available: label and ticket.

There are two types of sensors for paper: gap sensor and black mark sensor.

Label and ticket can be further classified into direct thermal type or thermal transfer type.

1.5.2 Specifications

Items	Label
Paper Width	Max.114mm
	Min. 25mm
Length (Pitch)	12~2286mm
Paper Thickness	0.20 mm
Paper Weight	Max 240 g/m ²
Max. Roll Diameter (1" core)	Inner roll diameter. Max 4.3" (110mm)
	External roll diameter. Max 8.4" (214mm)
Roll Up Method	Print surface wound outside as standard
Paper Core ID.	φ25.7±0.3mm

Note:

- (1) The width and thickness quoted above are said of the label plus its backing paper.
- (2) Likewise, the approval of label entails that of its backing paper.
- (3) In the peel off mode, the minimum pitch is 35mm.
- (4) In the cutter mode, it is required the paper be wound outside. Otherwise, paper jam tends to result.
- (5) In the cutter mode, the paper thickness is 0.2 mm at maximum, and the paper weight is 100 g/m² at maximum. Except for the linerless cutter, all regular/heavy duty/care label cutters DO NOT cut on media with glue.
- (6) Paper shape is as shown on next page.
- (7) Tag is 0.2mm in thickness, and is less than 100g/m² in weight.

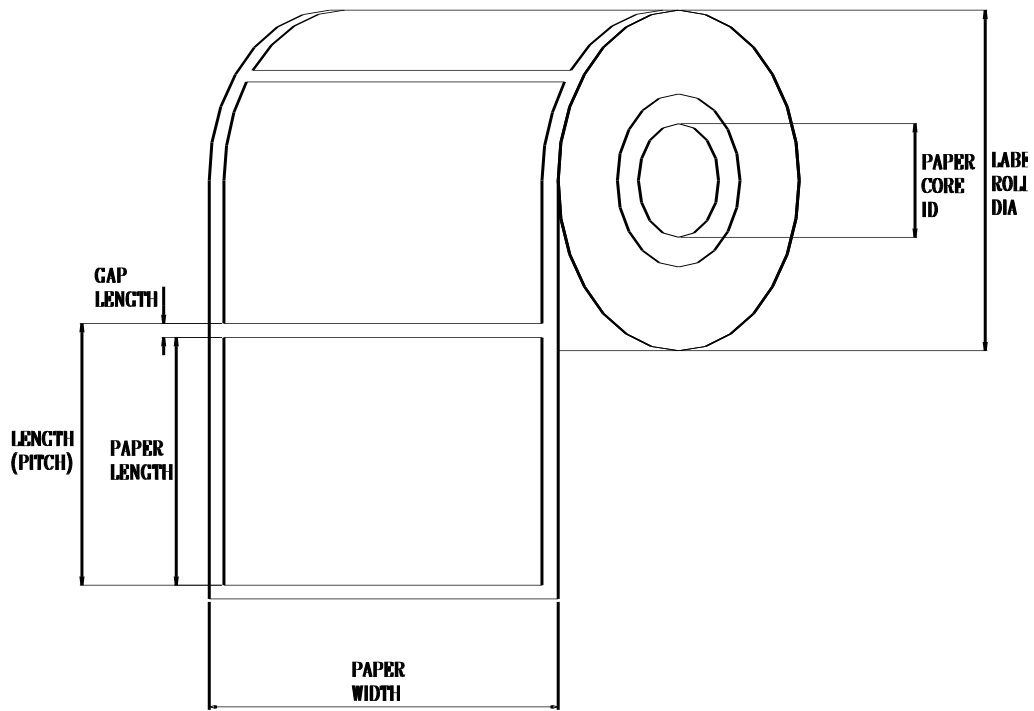

1.5.3 Ribbon Sizes and Shapes

Item	Specifications
Ribbon shape	Spool type
Ribbon width	Max. 110mm Min. 40mm
Ribbon winding width	Max. 110mm Min. 40mm
Leading tape	Polyester film, 335±5mm long
End tape	Polyester film (transparent), 250±5mm long
Max. ribbon OD.	φ67mm
Winding method	Ink surface to be wound outside

Note: The maximum length of ribbon depends on its thickness and core outside diameter.

The formula below defines the correlation between ribbon roll length and ribbon core diameter.

$$L = \frac{(D^2 - d^2) \times \pi}{4t}, \text{ where}$$

- L = Ribbon length
- D = Max. roll diameter
- d = Ribbon core outside diameter
- t = Ribbon thickness

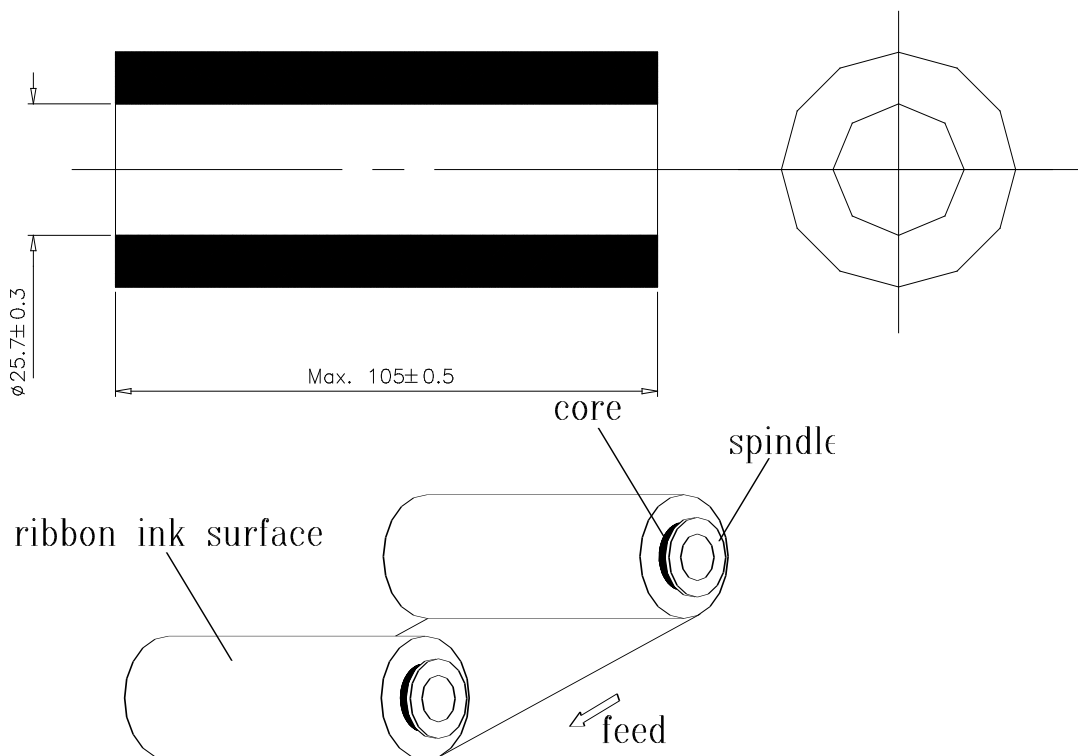

2. GETTING STARTED

2.1 Unpacking and Inspection

The printer has been specially packaged to withstand damage in the shipping process. However, for fear that unexpected damage might occur, upon receiving the bar code printer, carefully inspect the package and the device. In case of evident damage, contact the carrier directly to specify the nature and extent of the damage. Please retain the packaging materials in case you need to reship the printer.

2.2 Equipment Checklist

- * One bar code printer unit
- * One Windows labeling software/Driver CD disk
- * One quick start guide
- * One external auto switching power supply
- * One power cord
- * One label spindle
- * Two fixing tabs
- * Two ribbon spindles
- * One paper core for ribbon rewind spindle

If any parts are missing, please contact the Customer Service Department of your purchased reseller or distributor.

2.3 Printer Parts

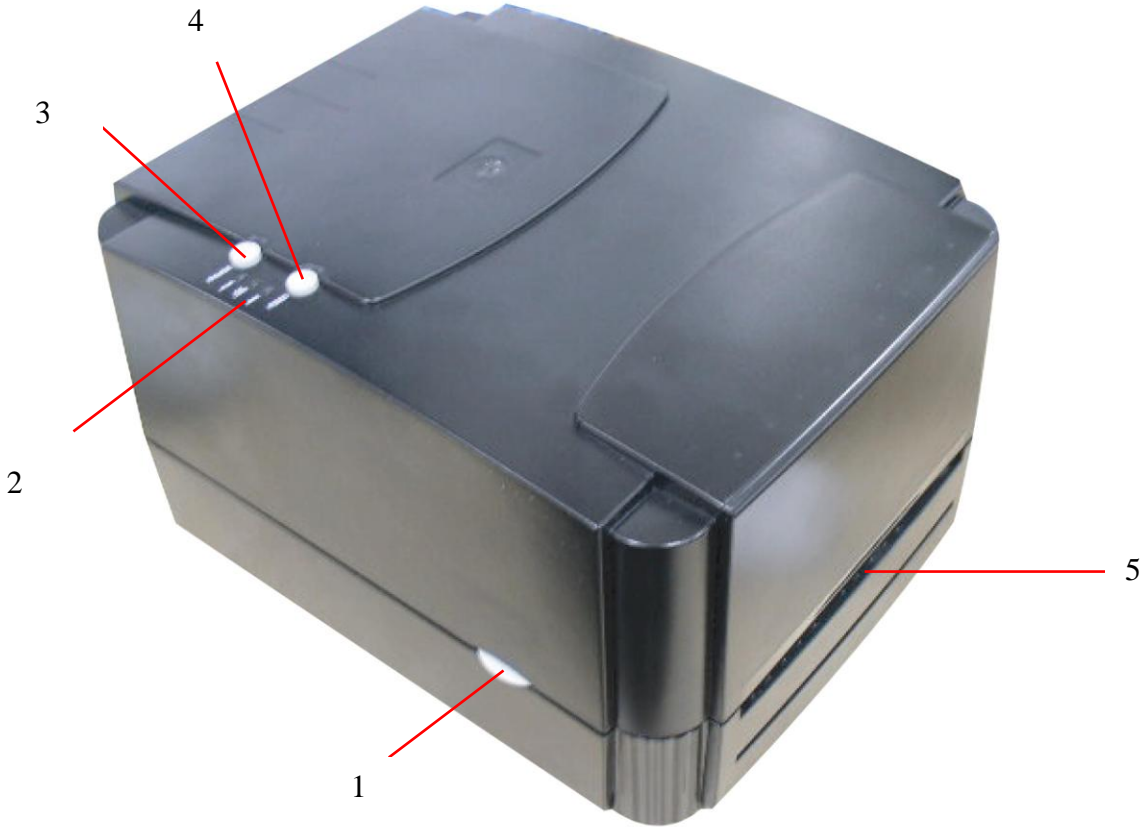

- 1. Cover Release Button
- 2. PWR., ON-LINE and ERR. Indicators
- 3. PAUSE Button
- 4. FEED Button
- 5. Label Dispense Opening

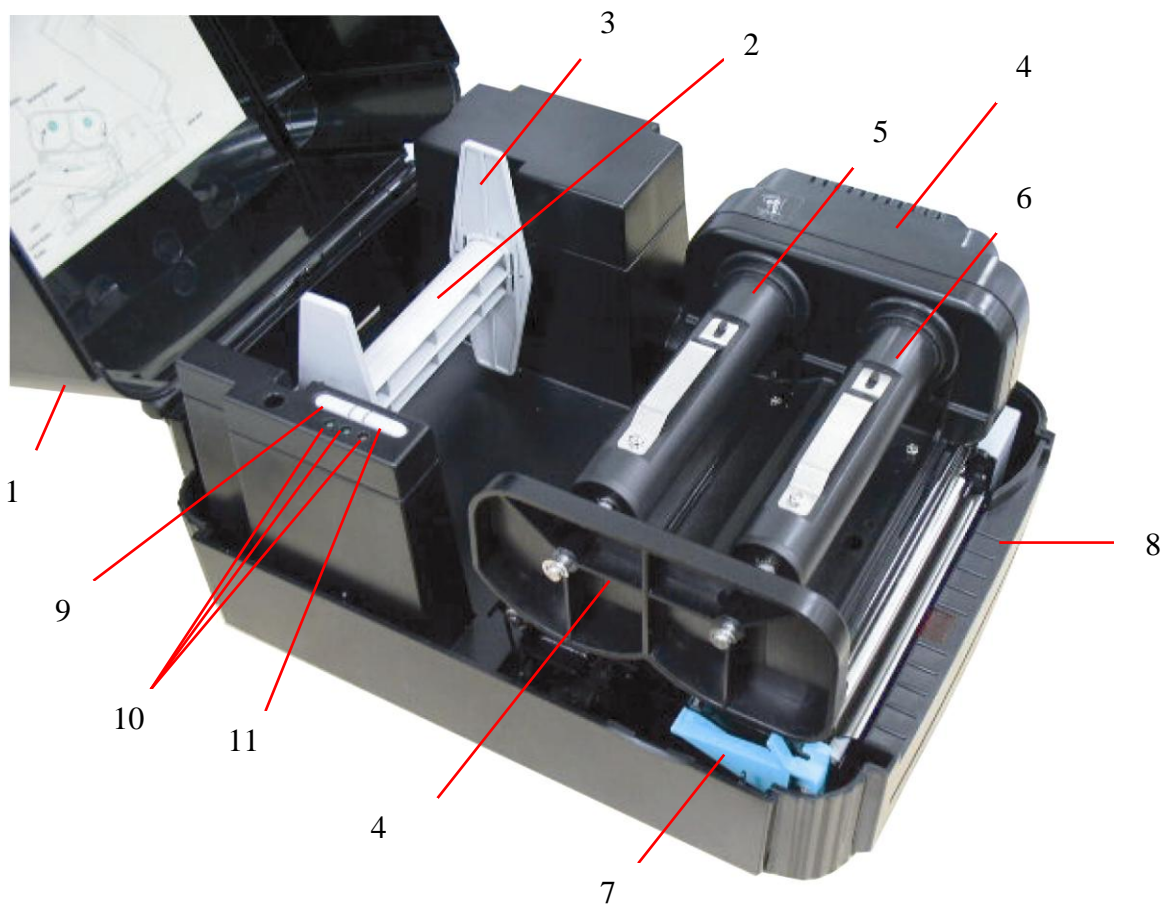

1. Printer Cover (in open position)
2. Label Supply Roll Spindle
3. Fixing Tabs
4. Ribbon Mechanism
5. Ribbon Supply Spindle
6. Ribbon Rewind Spindle
7. Printer Carriage Release Lever
8. Detachable Front Panel
9. PAUSE Button
10. PWR., ON-LINE, ERR. Indicators
11. FEED Button

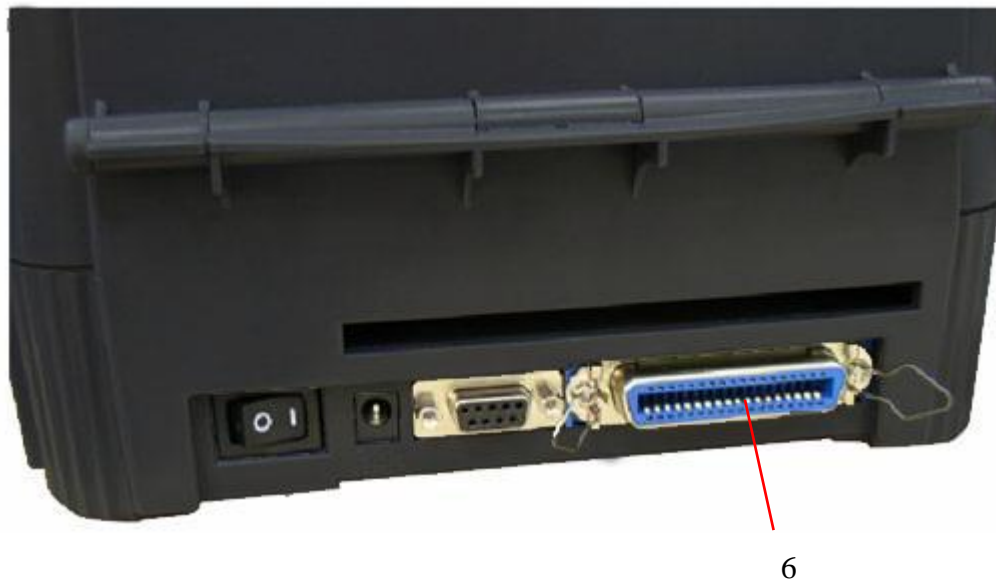
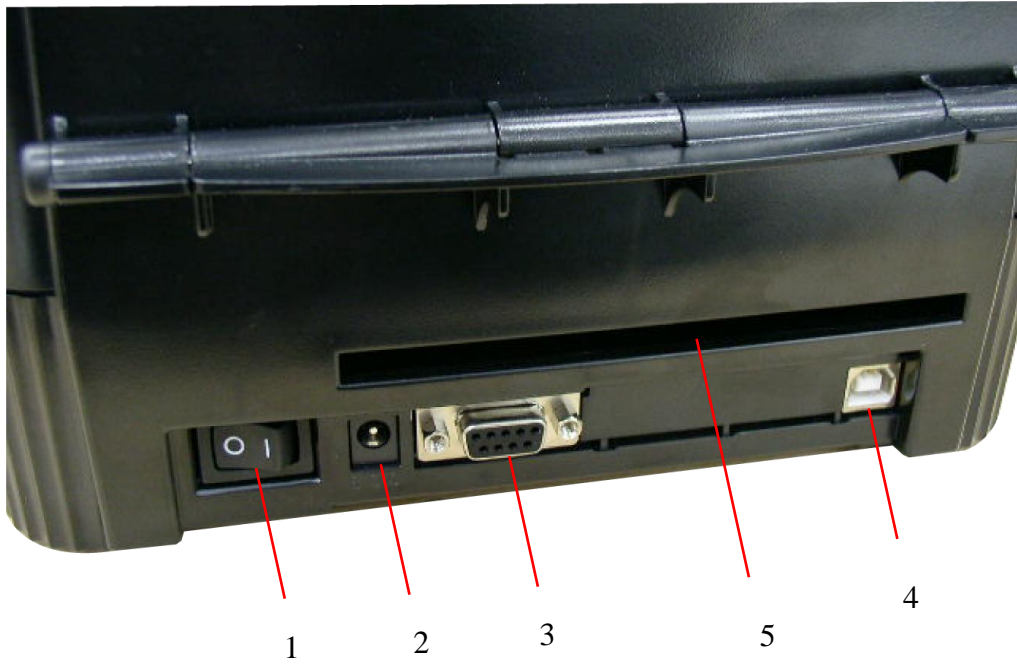

1. Power On/Off Switch
2. Power Supply DC Jacket
3. RS-232C Interface Connector
4. USB Interface Connector
5. Label Insert Opening (For use with external media)
6. Centronics Interface Connector (**Factory option**)

Note:

The interface picture here is for reference only. Please refer to the product specification for the interfaces availability.

2.4 External Label Roll Mount (Option)



2.5 Buttons and Indicators

PWR. (POWER) Indicator

The green **PWR.** indicator illuminates when the **POWER** switch is turned on.

ON-LINE Indicator

The green **ON-LINE** indicator illuminates when the printer is ready to print. When **PAUSE** button is pressed, the **ON-LINE** indicator flashes.

ERR. Indicator (Error/Paper Empty)

The red **ERR.** indicator illuminates in the event of a printer error, such as memory error, syntax error, and so forth. For a full list of error messages, please refer to section 4.2, Troubleshooting Guides.

PAUSE Button

The **PAUSE** button allows the user to stop a print job and then continue the printing with a second depression of the button. By pressing the **PAUSE** button: (1) the printer stops printing after the printing label, (2) the **PAUSE** LED flashes, and (3) the printer will hold all data in memory. This allows for trouble-free replacement of label stock and thermal transfer ribbon. A second depression of the **PAUSE** button will restart the printer.

Note: If the PAUSE button is held down for more than 3 seconds, the printer will be reset and all data of the previous printing job will be lost.

FEED Button

Press the **FEED** button to feed the label to the beginning of the next label.

3. SET UP

3.1 Setting Up the Printer

1. Place the printer on a flat, secure surface.
2. Make sure the **POWER** switch is off.
3. Connect the printer to the computer mainframe with the RS-232C or USB cable.



4. Plug the power cord into the power jacket at the rear of the printer, and then plug the power cord into a properly grounded receptacle.



Note:

Please switch OFF printer power switch prior to plug in the power cord to printer power jack.

3.2 Loading Label and Tag Stock

1. Open the printer cover.
2. Disengage the printer carriage by pulling the printer carriage release lever on the left side of the platen.

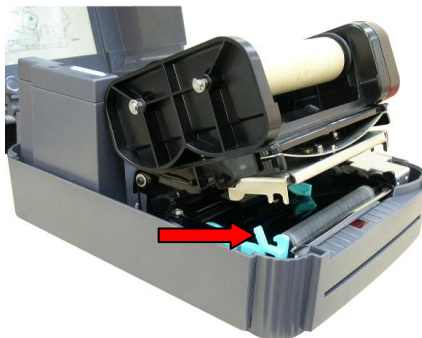

3. Slide the label supply roll spindle through the core of a label roll and attach the fixing tabs onto the spindle.



4. Place the label roll into the label roll mount. Feed the label under the carriage and over the platen.

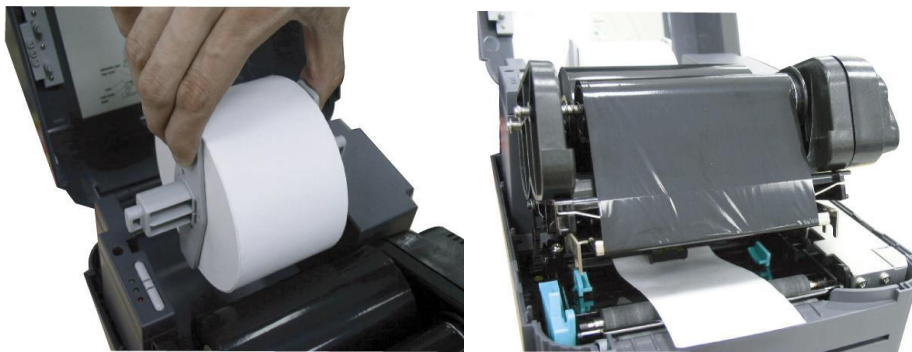

5. Adjust the label guide to fit the width of the media.

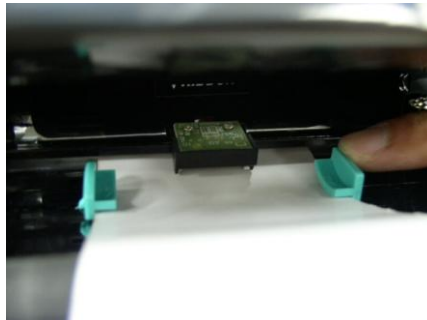

6. Engage the printer carriage.



7. Wind the label roll until it becomes adequately taut.
8. Close the printer cover and press the **FEED** button three or four times until the green **ON-LINE** indicator illuminates.
9. When the printer is out of ribbon or media, the **ON-LINE** LED will not illuminate and the **ERR.** LED will flash. Reload the ribbon or media without

turning off the printer power. Press the **FEED** button three or four times until the **ON-LINE** LED illuminates. The printing job will be resumed without data loss.

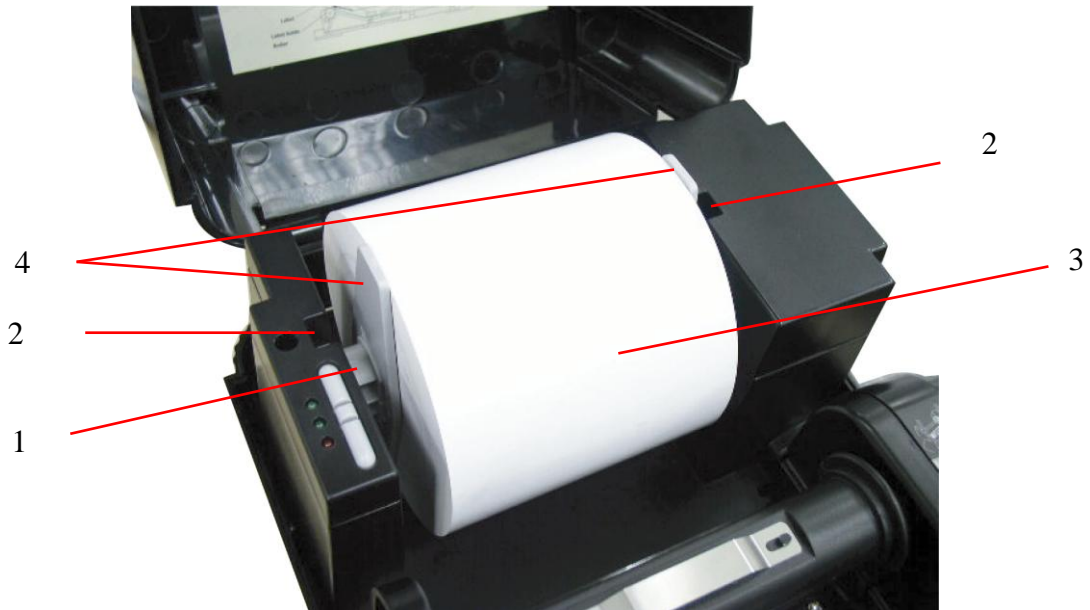

1. Label Supply Roll Spindle
2. Label Roll Mount
3. Label Roll
4. Fixing Tabs

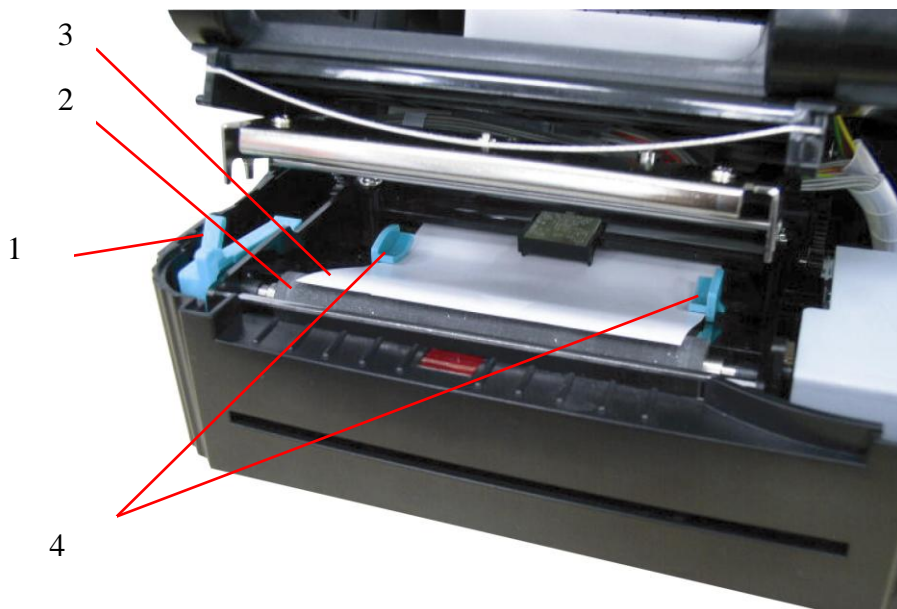

1. Printer Carriage Release Lever
2. Platen
3. Label Media

4. Adjustable Label Guide

Note:

Please refer to videos on [TSC YouTube](#) or driver CD.

3.3 Ribbon Loading Instructions

1. Place an empty paper core on the ribbon rewind spindle.

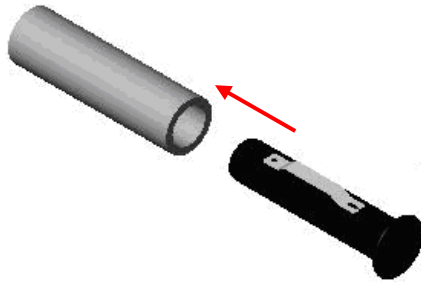

2. Insert the left side first. Mount the ribbon rewind paper core on the front hubs.



3. Please be noted that the bigger hub side with 4 ribs must be installed toward the right side of ribbon mechanism.



4. Install a ribbon on the ribbon supply spindle. Mount the ribbon supply spindle on the rear hubs.



5. Insert the left side first. Please be noted that the bigger hub side with 4 ribs must be installed toward the right side of ribbon mechanism.



6. Disengage the printer carriage by pulling the carriage release lever upwards.

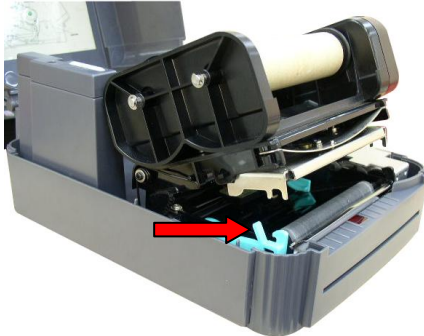

7. Following the direction of the ↓ **RIBBON** label, pull the transparent ribbon leader to the front from under the ribbon mechanism.



8. Attach the ribbon leader to the empty paper core on the ribbon rewind spindle (with a tape).

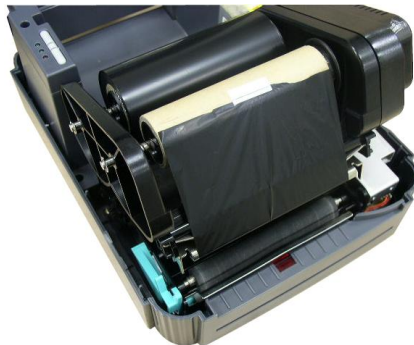

9. Rotate the ribbon rewind spindle until the ribbon overlaps the ribbon leader and stretches tight.



10. Engage the printer carriage.
11. Close the printer cover and press the **FEED** button until the green **ON-LINE** LED illuminates.

Note:

1. *Please install ribbon and media and close print head mechanism prior to turn on power. Printer will determine direct thermal or thermal transfer mode automatically while turning on printer power.*
2. *Please refer to videos on [TSC YouTube](#) or driver CD.*

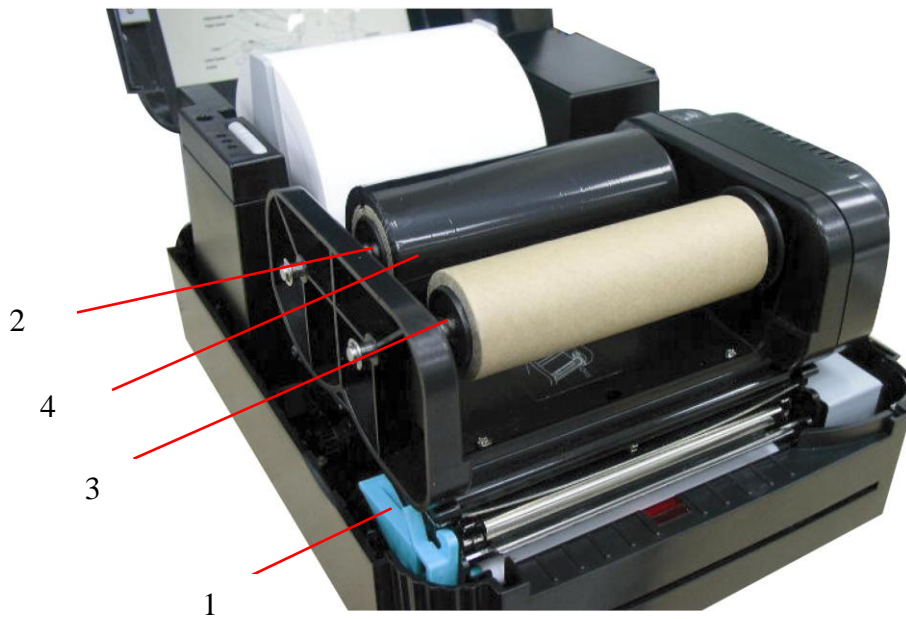

- 1. Printer Carriage Release Lever
- 2. Ribbon Supply Spindle
- 3. Ribbon Rewind Spindle
- 4. Thermal Transfer Ribbon



3.4 Install External Label Roll Mount (Option)

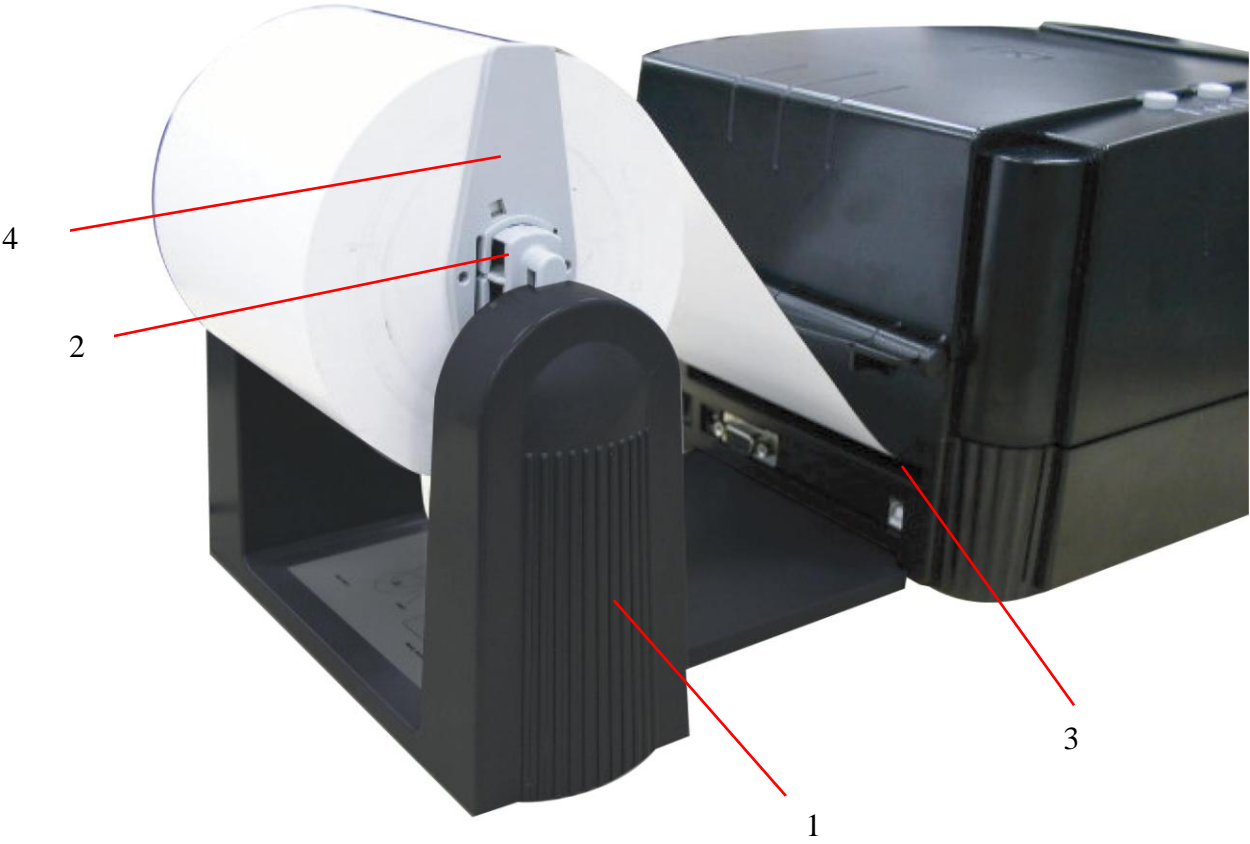

- 1. External Label Roll Mount
- 2. Label Supply Roll Spindle
- 3. External Label Feed Opening
- 4. Fixing Tabs

3.5 Self Test

To initiate the self test mode, depress the **FEED** button while turning on the printer power. The printer will calibrate the label length. If the label gap is not detected within 7", the printer stops feeding labels and the media is treated as continuous paper. In self test, a check pattern is used to check the performance of the thermal print head. Following the check pattern, the printer prints internal settings as listed below.

When the self test is completed, the printer enters the dump mode. Please turn the printer's power off and then on to resume normal printing.

Self-test printout	
<pre> PRINTER INFO. XX XX XXXXXXXXXX Version: X.XX MILAGE(m): 0 CHECKSUM: XXXXXXXX SERIAL PORT: 9600,N,8,1 CODE PAGE: 850 COUNTRY CODE: 001 SPEED: X INCH DENSITY: 8 SIZE: 4.00 , 4.00 GAP: 0.12 , 0.00 TRANSPARENCE: XX ***** FILE LIST: DRAM FILE: 0 FILE(S) FLASH FILE: 0 FILE(S) PHYSICAL DRAM: XXXX KBYTES AVAILABLE DRAM: XXXX KBYTES FREE PHYSICAL FLASH: XXXX KBYTES AVAILABLE FLASH: XXXX KBYTES FREE END OF FILE LIST ***** NOW IN DUMP MODE </pre>	<p>Print head check pattern Model name and F/W version Printed mileage (meter) Firmware checksum Serial port configuration Code page Country code Print speed (inch/sec) Print darkness Label size (inch) Gap distance (inch) Gap/black mark sensor sensitivity</p> <p>Numbers of download files Total & available memory space</p>
Self-test printout (with printer firmware V7.0 and later version)	
<pre> ----- SYSTEM INFORMATION ----- MODEL: XXXXXX FIRMWARE: X.XX CHECKSUM: XXXXXXXX S/N: XXXXXXXXXXXX TCF: NO DATE: 1970/01/01 TIME: 00:04:18 NON-RESET: 110 m (TPH) RESET: 110 m (TPH) NON-RESET: 0 (CUT) RESET: 0 (CUT) </pre>	<p>Model name F/W version Firmware checksum Printer S/N TSC configuration file System date System time Printed mileage (meter) Cutting counter</p>

```

-----
PRINTING SETTING
-----
SPEED: 5 IPS
DENSITY: 8.0
WIDTH: 4.00 INCH
HEIGHT: 4.00 INCH
GAP: 0.00 INCH
INTENSION: 5
CODEPAGE: 850
COUNTRY: 001
-----

```

Print speed (inch/sec)
 Print darkness
 Label size (inch)
 Gap distance (inch)
 Gap/black mark sensor intension
 Code page
 Country code

```

-----
Z SETTING
-----
DARKNESS: 16.0
SPEED: 4 IPS
WIDTH: 4.00 INCH
TILDE: 7EH (~)

CARET: 5EH (^)
DELIMITER: 2CH (,)
POWER UP: NO MOTION
HEAD CLOSE: NO MOTION
-----

```

ZPL setting information
 Print darkness
 Print speed (inch/sec)
 Label size
 Control prefix
 Format prefix
 Delimiter prefix
 Printer power up motion
 Printer head close motion

Note:
 ZPL is emulating for Zebra® language.

```

-----
RS232 SETTING
-----
BAUD: 9600
PARITY: NONE
DATA BIT: 8
STOP BIT: 1
-----

```

RS232 serial port configuration

```

-----
DRAM FILE (0 FILES)
-----
PHYSICAL XXXX KBYTES
AVAILABLE XXXX KBYTES
-----

FLASH FILE (0 FILES)
-----
PHYSICAL XXXX KBYTES
AVAILABLE XXXX KBYTES
-----

```

Numbers of download files
 Total & available memory space

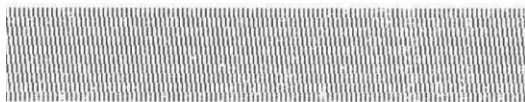

Print head check pattern

3.6 Dump Mode

After the self test, the printer enters the dump mode. In this mode, any characters sent from the host computer will be printed in two columns, as shown. The characters received will be shown in the first column, and their corresponding hexadecimal values, in the second. This is often helpful to users for the verification of programming commands or debugging of printer programs. Reset the printer by turning the **POWER** switch off and on.

```
*****
NOW IN DUMP MODE

DOWNLOAD "DE 44 4F 57 4E 4C 4F 41 44 20 22 44 45
MO2.BAS" SI 4D 4F 32 2E 42 41 53 22 0D 0A 53 49
ZE 4.00,5.00 5A 45 20 34 2E 30 30 2C 35 2E 30 30
  CLS SPEED 0D 0A 43 4C 53 0D 0A 53 50 45 45 44
  1.5 DENSIT 20 31 2E 35 0D 0A 44 45 4E 53 49 54
Y 10 DIRECT 59 20 31 30 0D 0A 44 49 52 45 43 54
ION 0 SET C 49 4F 4E 20 30 0D 0A 53 45 54 20 43
UTTER OFF S 55 54 54 45 52 20 4F 46 46 0D 0A 53
ET DEBUG LAB 45 54 20 44 45 42 55 47 20 4C 41 42
EL REFERENC 45 4C 0D 0A 52 45 46 45 52 45 4E 43
E 0,0 A=100 45 20 30 2C 30 0D 0A 41 3D 31 30 30
0 Y=100 FO 30 0D 0A 59 3D 31 30 30 0D 0A 46 4F
R I=1 TO 3 52 20 49 3D 31 20 54 4F 20 33 0D 0A
BARCODE 100, 42 41 52 43 4F 44 45 20 31 30 30 2C
Y, "39",.96,1, 59 2C 22 33 39 22 2C 39 36 2C 31 2C
0,2,4,STR$(A 30 2C 32 2C 34 2C 53 54 52 24 28 41
) A=A+1 Y= 29 0D 0A 41 3D 41 2B 31 0D 0A 59 3D
Y+150 NEXT 59 2B 31 35 30 0D 0A 4E 45 58 54 0D
PRINT 1 EO 0A 50 52 49 4E 54 20 31 0D 0A 45 4F
P DEMO2 50 0D 0A 44 45 4D 4F 32 0D 0A
```

ASCII Data →

Hex decimal data related to left column of ASCII data →

3.7 Install SD Memory Card (TTP-244 Plus Model only / Option)

1. Open the memory card cover.



Memory card cover

2. Plus the SD memory card module on the main board.

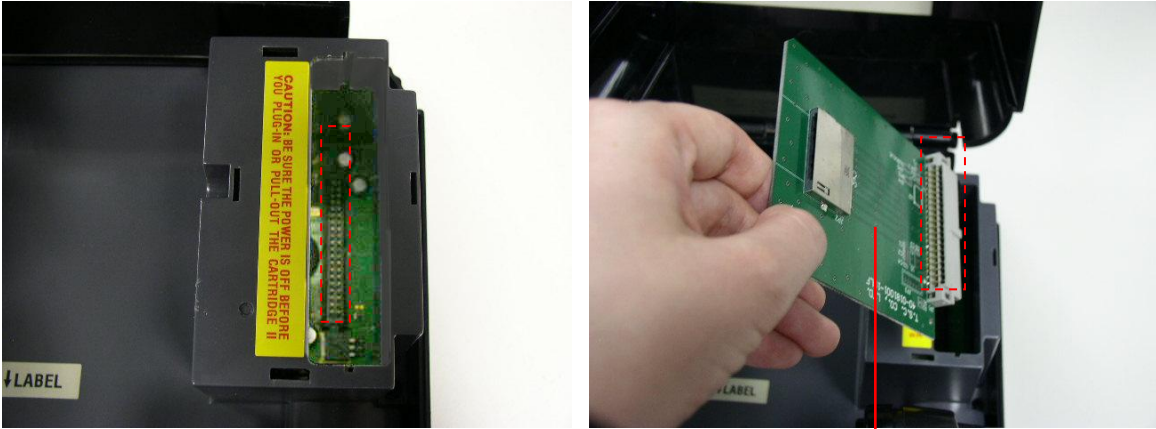

SD memory card module (Option)

3. Install the SD memory card.



SD card

4. Close the memory card cover.

* Recommended SD card specification.

SD card spec	SD card capacity	Approved SD card manufacturer
V1.0, V1.1	128 MB	SanDisk, Transcend
V1.0, V1.1	256 MB	SanDisk, Transcend, Panasonic
V1.0, V1.1	512 MB	SanDisk, Transcend, Panasonic
V1.0, V1.1	1 GB	SanDisk, Transcend, Panasonic
V2.0 SDHC CLASS 4	4 GB	
V2.0 SDHC CLASS 6	4 GB	SanDisk, Transcend, Panasonic
V1.0, V1.1	microSD 128 MB	Transcend, Panasonic
V1.0, V1.1	microSD 256 MB	Transcend, Panasonic
V1.0, V1.1	microSD 512 MB	Panasonic
V1.0, V1.1	microSD 1 GB	Transcend, Panasonic
V2.0 SDHC CLASS 4	microSD 4 GB	Panasonic
V2.0 SDHC CLASS 6	microSD 4 GB	Transcend
V1.0, V1.1	miniSD 128 MB	Transcend, Panasonic
V1.0, V1.1	miniSD 256 MB	Transcend, Panasonic
V1.0, V1.1	miniSD 512 MB	Transcend, Panasonic
V1.0, V1.1	miniSD 1 GB	Transcend, Panasonic
V2.0 SDHC CLASS 4	miniSD 4 GB	Transcend
V2.0 SDHC CLASS 6	miniSD 4 GB	
<ul style="list-style-type: none"> - The DOS FAT file system is supported for the SD card. - Folders/files stored in the SD card should be in the 8.3 filename format - The miniSD/microSD card to SD card slot adapter is required. 		

4. USING PRINTER

4.1 Power-on Utilities

There are three power-on utilities to set up and test hardware. These utilities are activated by pressing the **FEED** or **PAUSE** button and turning on the printer power simultaneously. The utilities are listed as below:

1. Self-test
2. Gap sensor calibration
3. Printer initialization

Note:

Please refer to videos on [TSC YouTube](#) or driver CD.

4.1.1 Self Test Utility

Install the label first. Press the **FEED** button and then turn on the printer power. Do not release the **FEED** button until the printer feeds labels. The printer performs the following items:

1. Calibrate label pitch
2. Print out thermal print head check pattern
3. Print the internal settings
4. Enter dump mode

Regarding the self-test and dump mode, please refer to section 3.5 "Self Test" and section 3.6 "Dump Mode" for more information.

4.1.2 Gap Sensor Calibration Utility

This utility is used to calibrate the sensitivity of gap sensor. Users may have to calibrate the gap sensor for two reasons:

1. The media is being changed to a new type.
2. Initialize the printer.

Note: The ERR. LED may flash if gap sensor is not calibrated properly.

Please follow the steps below to calibrate gap sensor:

1. Turn off the printer power and install blank labels (without any logo or character) on printer.
2. Hold down the **PAUSE** button then turn on printer power.

3. Release **PAUSE** button when the printer feeds labels. **Do not turn off printer power** until the printer stops and two green LEDs light on.

Note: Black mark sensor has fixed sensitivity. It is no need to calibrate the black mark sensor

4.1.3 Printer Initialization

Printer initialization sets printer parameters to default values. And it will not clear downloaded files resident in flash memory.

Parameter	Default setting
Speed	50.8 mm/sec (2 ips)
Density	8
Label Width	4" (101.6 mm)
Label Height	4" (101.6 mm)
Sensor Type	Gap sensor
Gap Setting	0.12" (3.0 mm)
Print Direction	0
Reference Point	0,0 (upper left corner)
Offset	0
Tear Mode	On
Peel off Mode	Off
Cutter Mode	Off
Serial Port Settings	9600 bps, none parity, 8 data bits, 1 stop bit
Code Page	850
Country Code	001
Clear Flash Memory	No

Please follow the steps below to initialize the printer:

1. Turn off the printer power.
2. Hold down the **PAUSE** and **FEED** buttons and turn on the printer power.
3. Do not release the buttons until the three LEDs flash in turn.

Note 1: Printing method (thermal transfer or thermal direct printing) will be set automatically at the activation of printer power.

Note 2: When printer initialization is done, sensor sensitivity is reset to default. Sensor calibration is required before printing labels.

Note 3: Download files will not be deleted after printer initialization. For more information about deleting files, please refer to TSPL2 programming manual KILL command.

4.2 Troubleshooting Guide

The following guide lists some of the most common problems that may be encountered when operating the bar code printer. If the printer still does not function after all suggested solutions have been invoked, please contact the Customer Service Department of your purchased reseller or distributor for assistance

Problem	Solution
Ribbon does not advance or rewind	<ol style="list-style-type: none"> 1. The media and ribbon must be installed then engage the print head mechanism prior to turning on printer power. 2. Install the black ribbon spindle at the correct direction. 3. Please check the "Media settings method" in the driver if it is set to direct thermal mode.
Poor print quality	<ol style="list-style-type: none"> 1. Clean the thermal print head. 2. Adjust the print density setting. 3. Ribbon and media are not compatible. 4. Media thickness is over spec. 5. Check if correct power supply is connected with printer.
Power indicator on printer does not illuminate	<ol style="list-style-type: none"> 1. Check the power cord, see whether it is properly connected. 2. Check if the LED on the power supply is illuminated. If it is not lit on, then the power supply is damaged. 3. Check if correct power supply is connected with printer.
ON-LINE indicator is off, ERR. indicator is on	<ol style="list-style-type: none"> 1. Out of paper or out of ribbon If there is one beep sound when printer is error, then it's gap sensor problem. Please check the following items. <ol style="list-style-type: none"> (1) Calibrate gap sensor or setup the paper length in labeling software/program properly. (2). Install the paper at the correct If there are two beeps sound when printer is error then it's ribbon sensor problem. Please check the following items. <ol style="list-style-type: none"> (1) Is outside wound ribbon is used with this printer? (2) Is ribbon threaded correctly in

	<p>the mechanism?</p> <p>(3) Is paper core installed on the ribbon take up spindle?</p> <p>2. Calibrate the sensitivity of gap sensor.</p>
<p>Continuous feeding when printing labels</p>	<ol style="list-style-type: none"> 1. Check the driver or command script setting if sensor type is set properly. 2. Calibrate the gap sensor again if die cut media is used for printing.

Update History

Date	Content	Editor
2010/10/12	Add section 1.2~1.5	Camille
2010/10/13	Revise section 1.3	Camille
2010/11/23	Revise sections 1, 2.3 and 3.1	Camille
2011/1/25	Modify TSC address	Camille
2013/3/21	Modify section 3.5	Camille
2013/4/1	Add a note for cutter SPEC on section 1.5.2 Add TSC YouTube link on section 3.2, 3.3 and 4.1	Camille
2013/9/17	Modify section 1.1	Camille



TSC Auto ID Technology Co., Ltd.

Corporate Headquarters

9F., No.95, Minquan Rd., Xindian Dist.,
New Taipei City 23141, Taiwan (R.O.C.)

TEL: +886-2-2218-6789

FAX: +886-2-2218-5678

Web site: www.tscprinters.com

E-mail: printer_sales@tscprinters.com
tech_support@tscprinters.com

Li Ze Plant

No.35, Sec. 2, Ligong 1st Rd., Wujie Township,
Yilan County 26841, Taiwan (R.O.C.)

TEL: +886-3-990-6677

FAX: +886-3-990-5577